

Dell 27 Plus QHD monitor

S2725DSM

User's Guide

Notes, cautions, and warnings

 **NOTE:** A NOTE indicates important information that helps you make better use of your product.

 **CAUTION:** A CAUTION indicates either potential damage to hardware or loss of data and tells you how to avoid the problem.

 **WARNING:** A WARNING indicates a potential for property damage, personal injury, or death.

Contents

Safety instructions	5
About your monitor	6
Package contents	6
Information available on the packaging	7
Product features	8
Operating system compatibility	11
Identifying parts and controls	11
Front view	11
Back view	12
Side view	12
Bottom view	13
Monitor specifications	14
Dell Display and Peripheral Manager (DDPM) for Windows	15
Resolution specifications	15
Supported video modes	15
Preset display modes	16
Electrical specifications	18
Physical characteristics	19
Environmental characteristics	20
Pin assignments	21
DisplayPort connector	21
HDMI connector	22
Plug-and-play capability	23
LCD monitor quality and pixel policy	23
Ergonomics	23
Handling and moving your display	25
Maintenance guidelines	26
Cleaning your monitor	26
Setting up the monitor	27
Attaching the stand	27
Connecting your monitor	29
Connecting the DisplayPort (DisplayPort to DisplayPort) cable (purchased separately)	29
Connecting the HDMI cable	29
Organizing your cables	31
Securing your monitor using Kensington lock (optional)	32
Removing the monitor stand	32
VESA wall-mounting (optional)	33
Using the tilt, swivel, pivot and height adjustment	34
Tilt and swivel adjustment	34
Height adjustment	34
Pivot adjustment	35
Adjusting the rotation display settings of your system	36
Operating the monitor	37
Turn on the monitor	37
Using the joystick control	38

Using the On-Screen Display (OSD) menu	39
Accessing the Menu Launcher	39
Using the navigation keys	40
Direct Key functions	41
Accessing the menu system	42
OSD messages	52
Initial Setup	52
OSD warning messages	54
Locking the control buttons	56
Setting the maximum resolution	57
Troubleshooting	58
Self-test	58
Built-in diagnostics	59
Common problems	60
Regulatory information	62
FCC notices (U.S. Only) and other regulatory information	62
EU product database for energy label and product information sheet	62
Contacting Dell	63
Revision History	64

Safety instructions

Use the following safety guidelines to protect your monitor from potential damage and to ensure your personal safety. Unless otherwise noted, each procedure included in this document assumes that you have read the safety information that is shipped with your monitor.

① **NOTE:** Before using the monitor, read the safety information that is shipped with your monitor and printed on the product. Keep the documentation at a secure location for future reference.

⚠ **WARNING:** Use of controls, adjustments, or procedures other than those specified in this documentation may result in exposure to shock, electrical hazards and/or mechanical hazards.

⚠ **CAUTION:** The possible long-term effect of listening to audio at high volume through the headphones (on a monitor that supports it) may damage your hearing ability.

- Place the monitor on a solid surface and handle it carefully.
 - The screen is fragile and can be damaged if dropped or pressed with a sharp object.
 - Ensure that your monitor is electrically rated to operate with the AC power available in your location.
 - Keep the monitor in room temperature. Excessive cold or hot conditions can have an adverse effect on the liquid crystal of the display.
 - Connect the power cable from the monitor to a wall outlet that is near and accessible. See [Connecting your monitor](#).
- Do not place and use the monitor on a wet surface or near water.
- Do not subject the monitor to severe vibration or high impact conditions. For example, do not place the monitor inside a car trunk.
- Unplug the monitor when it is going to be left unused for an extended period.
- To avoid electric shock, do not attempt to remove any cover or touch the inside of the monitor.
- Read these instructions carefully. Keep this document for future reference. Follow all warnings and instructions marked on the product.
- Certain monitors can be wall-mounted using the VESA mount that is sold separately. Ensure to use the correct VESA specifications as mentioned in the wall-mounted section of the User's Guide.

For information about safety instructions, see the Safety, Environmental, and Regulatory Information (SERI) document that is shipped with your monitor.







About your monitor

Package contents

The following table provides the list of components that are shipped with your monitor. If any component is missing, contact Dell. For more information, see [Contacting Dell](#).

NOTE: Some items may be optional and may not ship with your monitor. Some features may not be available in certain countries.

Table 1. Monitor components and descriptions.

Component image	Component description
	Display
	VESA cover
	Stand riser
	Stand base
	Power cable (varies by country or region)
	HDMI cable (cable length: 1.80 m)
	<ul style="list-style-type: none">• QR card• Safety, Environmental, and Regulatory Information

Information available on the packaging

Before you open the box, ensure that the box is oriented correctly:

1. Lay the packaging box on a flat surface such that the opening flap is at the top.
2. Lift the opening flap and remove the components.

The ports on the monitor are as follows:

- 1 HDMI 2.1 TMDS port (HDCP 1.4)
- 1 DisplayPort 1.4 port (HDCP 1.4)

The following are the accessories that ship within the box:

- Power cable
- HDMI cable

For information about recycling, see the [Dell recycling](#) website.

Product features

The Dell S2725DSM monitor has an active matrix, Thin-Film Transistor (TFT), Liquid Crystal Display (LCD), anti-static, and LED backlight. The monitor features include:

- 684.7 mm (27.0 in.) viewable area display (measured diagonally).
- 2560 x 1440 resolution, with full-screen support for lower resolutions.
- Supports AMD FreeSync Technology for tear-free, stutter-free, low latency gaming.
- Supports the high refresh rates of 144 Hz and a rapid response time of 1 ms in MPRT mode.
- **NOTE:** 1 ms is achievable in the MPRT mode to reduce visible motion blur and increase image responsiveness. However, this may introduce slight and noticeable visual artifacts into the image. As every system setup and every gamer's needs are different, we recommend that users experiment with the different modes to find the setting that is right for them.
- Wide viewing angles of 178 degrees in vertical and horizontal directions.
- Color gamut of sRGB 99% (CIE 1931) (typical).
- Digital connectivity with one HDMI port and one DisplayPort.
- Plug-and-play capability (if supported by your computer).
- Built-in speakers (2 x 3 W).
- On-Screen Display (OSD) adjustments for ease of setup and screen optimization.
- Removable stand and Video Electronics Standards Association (VESA) 100 mm mounting holes for flexible mounting solutions.
- Tilt, swivel, pivot, and height adjustment capabilities.
- Power and joystick buttons lock.
- Power consumption ≤ 0.3 W in Standby mode.
- Security-lock slot for Kensington locks (sold separately).
- Supports Dell Display and Peripheral Manager.
- Dell ComfortView Plus is an integrated low blue light screen feature that improves eye comfort by reducing potentially harmful blue light emissions without compromising color. Through ComfortView Plus technology, Dell has reduced harmful blue light exposure from $\leq 50\%$ to $\leq 35\%$. This monitor is certified with TÜV Rheinland Eye Comfort 3.0 with a 4-star rating. It incorporates key technologies that also deliver a flicker-free screen, up to 144 Hz refresh rate, a color gamut of minimum 95% sRGB. Dell ComfortView Plus feature is enabled by default on your monitor.
- This monitor uses a low blue light panel. When the monitor is reset to factory settings or default setting, it is in compliance with TÜV Rheinland's hardware low blue light certification.*
* This monitor is in compliance with TÜV Rheinland hardware low blue light certification under Category 2.

Blue light ratio:

The ratio of light in the range from 415 nm-455 nm compared to 400 nm-500 nm is is less than 35%.

Table 2. Blue light ratio.

Category	Blue light ratio
1	$\leq 20\%$
2	$20\% < R \leq 35\%$
3	$35\% < R \leq 50\%$

- Decreases the level of hazard blue light emitted from the screen to make viewing more comfortable for your eyes without distortion of color accuracy.
- The monitor features Flicker-Free technology, eliminating visible flicker to provide a comfortable viewing experience and help prevent eye strain and fatigue.

About TÜV Rheinland Eye Comfort 3.0

TÜV Rheinland Eye Comfort 3.0 certification program presents a consumer-friendly star rating scheme to the display industry thereby promoting eye wellness from safety to eye care. Compared to existing certifications, the 5-star-rating program adds rigorous testing requirements on overall eye care attributes such as low blue-light, flicker-free, refresh rate, color gamut, color accuracy, and ambient light sensor performance. It lays out requirement metrics and rates the product performance on five levels, and the sophisticated technical assessment process provides consumers and buyers with indicators that are easier to judge.



The eye wellness factors being considered remain constant, however, the standards for the various star ratings are different. The higher the star rating, the more stringent the standards. The table below lists the major eye comfort requirements which apply in addition to the basic eye comfort requirements (such as pixel density, uniformity of luminance and color, and freedom of movement).

For more information around **TÜV Eye Comfort certification**, see [Eye Comfort Certification](#).

Table 3. Eye Comfort 3.0 Requirements and Star Rating Scheme for Monitors.

Eye Comfort 3.0 Requirements and Star Rating Scheme for Monitors				
Category	Test item	Star Rating Scheme		
		3-star	4-star	5-star
Eye Care	Low Blue Light	TÜV Hardware LBL Category III ($\leq 50\%$) or Software LBL solution ¹	TÜV Hardware LBL Category II ($\leq 35\%$) or Category I ($\leq 20\%$)	TÜV Hardware LBL Category II ($\leq 35\%$) or Category I ($\leq 20\%$)
	Flicker Free	TÜV Flicker Reduced or TÜV Flicker Free	TÜV Flicker Reduced or TÜV Flicker Free	Flicker Free
Ambient Light Management	Ambient Light Sensor performance	No sensor	No sensor	Ambient light sensor
	Intelligent CCT control	No	No	Yes
	Intelligent Luminance control	No	No	Yes
Image quality	Refresh Rate	≥ 60 Hz	≥ 75 Hz	≥ 120 Hz
	Luminance uniformity	Luminance uniformity $\geq 75\%$		
	Color Uniformity	Color uniformity $\Delta u'v' \leq 0.02$		
	Freedom of movement	Luminance changes shall decrease less than 50%; The color shift shall be less than 0.01.		
	Gamma difference	Gamma difference $\leq \pm 0.2$	Gamma difference $\leq \pm 0.2$	Gamma difference $\leq \pm 0.2$
	Wide color gamut ²	NTSC ³ Min.72% (CIE 1931) or sRGB ⁴ Min 95% (CIE 1931)	sRGB ⁴ Min.95% (CIE 1931)	DCI-P3 ⁵ Min. 95% (CIE 1976) and sRGB ⁴ Min.95% (CIE 1931) or Adobe RGB ⁶ Min.95% (CIE 1931) and sRGB ⁴ Min.95% (CIE 1931)
Eye Comfort User Guide	User guide	Yes	Yes	Yes
Remark	<p>¹ Software controls the blue light emission by reducing excessive blue light, resulting in a more yellow tone.</p> <p>² Color gamut describes the availability of colors in the display. Various standards were developed for specific purposes. 100% corresponds to the full color space as defined in the standard.</p> <p>³ NTSC stands for National Television Standards Committee, which developed a color space for the television system that is used in the United States.</p> <p>⁴ sRGB is a standard red, green, and blue color space that is in use on monitors, printers, and the World Wide Web.</p> <p>⁵ DCI-P3, short for Digital Cinema Initiatives - Protocol 3, is a color space used in digital cinema that encompasses a wider range of colors than the standard RGB color space.</p> <p>⁶ Adobe RGB is a color space which is created by Adobe Systems that encompasses a broader range of colors than the standard RGB color model, particularly in the cyans and greens.</p>			

Operating system compatibility

- Windows 10, Windows 11, and later*
- macOS 13*, macOS 14*, and macOS 15*

*The operating system compatibility on Dell branded monitors may vary based on factors such as:

- Specific release date(s) when operating system versions, patches, or updates are available.
- Specific release date(s) when Dell branded monitor firmware, software application, or driver updates are available on the Dell support website.

Identifying parts and controls

Front view



Figure 1. Front view of the monitor

Table 4. Components and descriptions.

Label	Description	Use
1	Power LED indicator	Solid white light indicates that the monitor is turned on and is functioning normally. Blinking white light indicates that the monitor is in Standby Mode.

Back view



Figure 2. Back view of the monitor

Table 5. Components and descriptions.

Label	Description	Use
1	VESA mounting holes (4) (100 mm x 100 mm - behind attached VESA cover)	Wall-mount the monitor using VESA-compatible wall mount kit. NOTE: Wall-mount kit is not shipped with your monitor and is sold separately.
2	Regulatory information label	Lists the regulatory approvals.
3	Joystick	Use to control the OSD menu. For more Information, see Operating the monitor .
4	Power button	To turn the monitor on or off.
5	Regulatory label (including MyDell QR code, serial number, and Service Tag label)	See this label if you need to contact Dell for technical support. The Service Tag is a unique alphanumeric identifier that enables Dell service technicians to identify the hardware components in your monitor and access warranty information.
6	Stand release button	Releases the stand from the monitor.
7	Cable management guide	Use to organize the cables by routing them through the guide.

Side view



Figure 3. Side view of the monitor

Bottom view

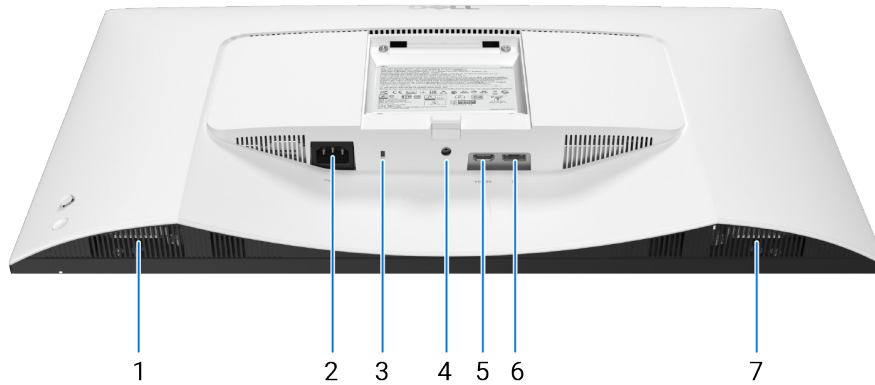





Figure 4. Bottom view of the monitor

Table 6. Components and descriptions.

Label	Description	Use
1	Built-in right speaker	Provides audio output.
2	 Power connector	Connect the power cable (shipped with your monitor).
3	Security-lock slot (based on Kensington Security Slot)	Secure your monitor using a security lock (purchased separately) to prevent unauthorized movement of your monitor.
4	Stand-lock feature	Lock the stand to the monitor using a M3 x 6 mm screw (screw not included).
5	 HDMI port	Connect your computer with the HDMI cable shipped with your monitor.
6	 DisplayPort	Connect your computer with the DisplayPort cable (purchased separately).
7	Built-in left speaker	Provides audio output.

Monitor specifications

Table 7. Monitor specifications.

Description	Value
Screen type	Active matrix - TFT LCD
Panel technology	In-Plane Switching (IPS) Technology
Aspect ratio	16:9
Viewable image dimensions	
Diagonal	684.7 mm (27.0 in.)
Active area	
Horizontal	596.74 mm (23.49 in.)
Vertical	335.66 mm (13.22 in.)
Area	200301.75 mm ² (310.47 in. ²)
Pixel pitch	
Horizontal	0.2331 mm
Vertical	0.2331 mm
Pixel per inch (PPI)	109
Viewing angle	
Horizontal	178° (typical)
Vertical	178° (typical)
Brightness	350 cd/m ² (typical)
Contrast ratio	1500:1 (typical)
Display screen coating	Anti-glare with hard-coating 3H
Backlight	LED Edgelight System
Response time	<ul style="list-style-type: none"> • MPRT mode: 1 ms • Extreme mode: 4 ms (gray to gray) • Fast mode: 5 ms (gray to gray) • Normal mode: 8 ms (gray to gray) <p>NOTE: In Extreme mode, slight artifacts may be encountered due to overdriving for fast speed and responsiveness. Use Normal / Fast mode for optimal front of screen experience and game play.</p>
Color depth	16.7 million colors
Color gamut	sRGB 99% (CIE 1931) (typical)
Connectivity	<ul style="list-style-type: none"> • 1 HDMI port (HDCP 1.4) - Supports up to QHD 2560x1440 144 Hz TMDS, VRR as per specified in HDMI 2.1 • 1 DisplayPort 1.4 port (HDCP 1.4) - Supports up to QHD 2560x1440 144 Hz, AdaptiveSync
Border width (edge of monitor to active area)	
Top	7.30 mm (0.29 in.)
Left/Right	7.30 mm (0.29 in.)
Bottom	13.02 mm (0.51 in.)
Adjustability	
Height adjustable stand	0 mm to 110 mm
Tilt	-5° to 21°
Swivel	-30° to 30°
Pivot	-90° to 90°

Description	Value
Cable management	Yes
Dell Display and Peripheral Manager	Yes
Security	Security-lock slot (for Kensington locks, sold separately)
Built-in speakers	2 x 3 W

Dell Display and Peripheral Manager (DDPM) for Windows

DDPM is a software application that helps you set up and configure the Dell monitors and peripherals. Some of its features include:

- Adjusting the monitor On-Screen Display (OSD) settings such as brightness, contrast, and resolution without needing to use the joystick on the monitor.
- Arrange multiple applications on your screen by placing them into a template of your choice using **Easy Arrange**.
- Assign applications or files to the partitions of **Easy Arrange**, save the layout as a profile, and restore the profile automatically with **Easy Arrange Memory** when needed.
- Connect the Dell Monitor to multiple input sources and manage these video inputs using the **Input Source** feature.
- Customize each application with its own distinct color mode using the **Color Preset** feature.
- Replicate software application settings from one monitor to another identical monitor using the **Import/Export** application settings feature.
- Receive notifications and update the firmware and software.
- Also, if the display supports the Network KVM feature, then you can share the keyboard and mouse across computers on the same network and transfer files between them.

NOTE: Some features of the DDPM mentioned above are available only on select monitor models. For more information about DDPM, and the recommended computer configuration to install it, go to [DDPM at Dell Support Site](#).

Resolution specifications

Table 8. Resolution specifications.

Description	Value
Horizontal scan range	27 kHz to 218 kHz (automatic)
Vertical scan range	48 Hz to 144 Hz (automatic)
Maximum preset resolution	2560 x 1440 at 144 Hz

Supported video modes

Table 9. Supported video modes.

Description	Value
Video display capabilities (HDMI and DisplayPort)	480p, 576p, 720p, 1080p

Preset display modes

Table 10. HDMI preset display modes.

Display mode	Horizontal frequency (kHz)	Vertical frequency (Hz)	Pixel clock (MHz)	Sync polarity (Horizontal/Vertical)
VESA 640 x 480	31.47	59.94	25.18	-/-
VESA 640 x 480	37.50	75.00	31.50	-/-
IBM 720 x 400	31.47	70.08	28.32	-/+
VESA 800 x 600	37.88	60.32	40.00	+/+
VESA 800 x 600	46.88	75.00	49.50	+/+
VESA 1024 x 768	48.36	60.00	65.00	-/-
VESA 1024 x 768	60.02	75.03	78.75	+/+
VESA 1152 x 864	67.50	75.00	108.00	+/+
VESA 1280 x 720	45.00	59.94	74.25	-/+
VESA 1280 x 800	49.31	59.91	71.00	+/+
VESA 1280 x 960	60.00	60.00	108.00	+/+
VESA 1280 x 1024	63.98	60.02	108.00	+/+
VESA 1280 x 1024	79.98	75.02	135.00	+/+
VESA 1440 x 900	55.94	59.89	106.50	-/+
VESA 1680 x 1050	65.29	59.95	146.25	-/+
VESA 1920 x 1080	67.50	60.00	148.50	+/+
VESA 2560 x 1440	88.79	59.95	241.50	+/-
VESA 2560 x 1440	183.00	120.00	497.75	+/-
VESA 2560 x 1440	217.39	143.97	591.31	+/-

Table 11. DisplayPort preset display modes.

Display mode	Horizontal frequency (kHz)	Vertical frequency (Hz)	Pixel clock (MHz)	Sync polarity (Horizontal/Vertical)
VESA 640 x 480	31.47	59.94	25.18	-/-
VESA 640 x 480	37.50	75.00	31.50	-/-
IBM 720 x 400	31.47	70.08	28.32	-/+
VESA 800 x 600	37.88	60.32	40.00	+/+
VESA 800 x 600	46.88	75.00	49.50	+/+
VESA 1024 x 768	48.36	60.00	65.00	-/-
VESA 1024 x 768	60.02	75.03	78.75	+/+
VESA 1152 x 864	67.50	75.00	108.00	+/+
VESA 1280 x 720	45.00	59.94	74.25	-/+
VESA 1280 x 800	49.31	59.91	71.00	+/+
VESA 1280 x 960	60.00	60.00	108.00	+/+
VESA 1280 x 1024	63.98	60.02	108.00	+/+
VESA 1280 x 1024	79.98	75.02	135.00	+/+
VESA 1440 x 900	55.94	59.89	106.50	-/+
VESA 1680 x 1050	65.29	59.95	146.25	-/+
VESA 1920 x 1080	67.50	60.00	148.50	+/+
VESA 2560 x 1440	88.79	59.95	241.50	+/-
VESA 2560 x 1440	183.00	120.00	497.75	+/-
VESA 2560 x 1440	222.15	143.97	604.25	+/-

NOTE: The monitor also supports other display resolutions that are not listed in the preset mode.

Electrical specifications

Table 12. Electrical specifications.

Description	Value
Video input signals	DisplayPort*/HDMI 2.1 (TMDS)**, 600 mV for each differential line, 100 ohm input impedance per differential pair
Input voltage/frequency/current	100 VAC-240 VAC/50 Hz or 60 Hz \pm 3 Hz/1.5 A (typical)
Inrush current	<ul style="list-style-type: none"> • 120 V: 30 A (maximum) at 0°C (cold start) • 240 V: 60 A (maximum) at 0°C (cold start)
Power consumption	<ul style="list-style-type: none"> • 0.3 W (Off Mode)¹ • 0.3 W (Standby Mode)¹ • 21.4 W (On Mode)¹ • 65.0 W (Maximum)² • 19.6 W (Pon)³ • 61.5 kWh (TEC)³

* DisplayPort: HBR3 is supported.

** HDMI port (HDCP 1.4) (supports up to QHD 2560 x 1440 144 Hz TMDS as per specified in HDMI 2.1).

¹ As defined in EU 2019/2021 and EU 2019/2013.

² Max brightness and contrast setting.

³ P_{on}: Power consumption of On mode as defined in Energy Star 8.0 version.

TEC: Total energy consumption in kWh as defined in Energy Star 8.0 version.

This document is for informational purposes only and reflects laboratory performance. Your product's performance may vary based on the software, components, and peripherals you have ordered. There is no obligation to update this information.

Accordingly, the customer should not rely upon this information in making decisions about electrical tolerances or otherwise. No warranty as to accuracy or completeness is expressed or implied.

NOTE: This monitor is ENERGY STAR certified.

ENERGY STAR is a program run by the U.S. Environmental Protection Agency (EPA) and the U.S. Department of Energy (DOE) that promotes energy efficiency.



This product qualifies for ENERGY STAR in the factory default settings, and this is the setting in which power savings is achieved.

Changing the factory default picture settings or enabling other features increases the power consumption that could exceed the limits necessary to qualify for an ENERGY STAR rating.

For more information about the ENERGY STAR program, go to [Energy Star Site](#).

Physical characteristics

Table 13. Physical characteristics.

Description	Value
Signal cable type	<ul style="list-style-type: none"> • DisplayPort, 20 pins (cable not included) • HDMI port, 19 pins
<p>NOTE: Dell monitors are designed to work optimally with the video cables that are shipped with your monitor. As Dell does not have control over the different cable suppliers in the market, the type of material, connector and process used to manufacture these cables, Dell does not guarantee video performance on cables that are not shipped with your Dell monitor.</p>	
Dimensions (with stand)	
Height (extended)	500.13 mm (19.69 in.)
Height (compressed)	390.13 mm (15.36 in.)
Width	611.34 mm (24.07 in.)
Depth	201.83 mm (7.95 in.)
Dimensions (without stand)	
Height	355.98 mm (14.02 in.)
Width	611.34 mm (24.07 in.)
Depth	58.87 mm (2.32 in.)
Stand dimensions	
Height (extended)	393.30 mm (15.48 in.)
Height (compressed)	352.79 mm (13.89 in.)
Width	256.00 mm (10.08 in.)
Depth	201.83 mm (7.95 in.)
Weight	
Weight with packaging	8.83 kg (19.48 lb)
Weight with stand assembly and cables	6.39 kg (14.09 lb)
Weight without stand assembly (no cables)	4.34 kg (9.57 lb)
Weight of stand assembly	1.81 kg (3.98 lb)

Environmental characteristics

Table 14. Environmental characteristics.

Description	Value
Compliant Standards	<ul style="list-style-type: none"> ENERGY STAR certified monitor RoHS-compliant Product Safety, EMC and Environmental Datasheets Dell Regulatory Compliance Home Page Dell and the Environment TÜV Eye Comfort 4 Star BFR/PVC reduce monitor (Circuit boards are made from BFR/PVC-free laminates). Arsenic-free glass and Mercury-free for the panel only
Temperature	
Operating	0°C to 40°C (32°F to 104°F)
Non-operating	<ul style="list-style-type: none"> Storage: -20°C to 60°C (-4°F to 140°F) Shipping: -20°C to 60°C (-4°F to 140°F)
Humidity	
Operating	10% to 80% (non-condensing)
Non-operating	<ul style="list-style-type: none"> Storage: 5% to 90% (non-condensing) Shipping: 5% to 90% (non-condensing)
Altitude	
Operating (maximum)	5,000 m (16,404 ft)
Non-operating (maximum)	12,192 m (40,000 ft)
Thermal dissipation	<ul style="list-style-type: none"> 221.9 BTU/hour (maximum) 73.0 BTU/hour (On Mode)

Pin assignments

DisplayPort connector

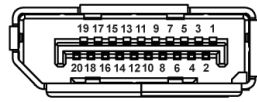

Figure 5. DisplayPort connector

Table 15. Pin assignments - DisplayPort connector.

Pin number	20-pin side of the connector
1	ML3 (n)
2	GND
3	ML3 (p)
4	ML2 (n)
5	GND
6	ML2 (p)
7	ML1 (n)
8	GND
9	ML1 (p)
10	ML0 (n)
11	GND
12	ML0 (p)
13	GND
14	GND
15	AUX (p)
16	GND
17	AUX (n)
18	Hot Plug Detect
19	Re-PWR
20	+3.3 V DP_PWR

HDMI connector

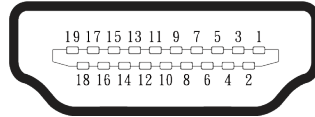

Figure 6. HDMI connector

Table 16. Pin assignments - HDMI connector.

Pin number	19-pin side of the connector
1	TMDS DATA 2+
2	TMDS DATA 2 SHIELD
3	TMDS DATA 2-
4	TMDS DATA 1+
5	TMDS DATA 1 SHIELD
6	TMDS DATA 1-
7	TMDS DATA 0+
8	TMDS DATA 0 SHIELD
9	TMDS DATA 0-
10	TMDS CLOCK+
11	TMDS CLOCK SHIELD
12	TMDS CLOCK-
13	CEC
14	Reserved (N.C. on device)
15	DDC CLOCK (SCL)
16	DDC DATA (SDA)
17	DDC/CEC Ground
18	+5 V POWER
19	HOT PLUG DETECT

Plug-and-play capability

You can connect the monitor to any Plug and Play-compatible system. The monitor automatically provides the computer with its Extended Display Identification Data (EDID) using Display Data Channel (DDC) protocols so that the computer can configure itself and optimize the monitor settings. Most monitor installations are automatic; you can select different settings as required. For more information about changing the monitor settings, see [Operating the monitor](#).

LCD monitor quality and pixel policy

During the LCD monitor manufacturing process, it is not uncommon for one or more pixels to become fixed in an unchanging state which are hard to see and do not affect the display quality or usability. For more information on Dell Monitor Quality and Pixel Policy, see [Dell Display Pixel Guidelines](#).

Ergonomics

△ CAUTION: Improper or prolonged usage of a keyboard may result in injury.

△ CAUTION: Viewing the monitor screen for extended periods of time may result in eye strain.

For comfort and efficiency, observe the following guidelines when setting up and using your computer workstation:

- Position your computer so that the monitor and keyboard are directly in front of you as you work. Special shelves are commercially available to help you correctly position your keyboard.
- To reduce the risk of eye strain and neck, arm, back, or shoulder pain from using the monitor for a long period, we recommend you to:
 - Set the distance of the screen between 20 in. to 28 in. (50 cm - 70 cm) from your eyes.
 - Blink frequently to moisten your eyes or wet your eyes with water after prolonged usage of the monitor.
 - Take regular and frequent breaks for 20 minutes every two hours.
 - Look away from your monitor and gaze at a distant object that is 20 feet away for at least 20 seconds during the breaks.
 - Perform stretches to relieve tension in the neck, arms, back, and shoulders during the breaks.
- Ensure that the monitor screen is at the eye level or slightly lower when you are sitting in front of the monitor.
- Adjust the tilt of the monitor, its contrast, and brightness settings.
- Adjust the ambient lighting around you (such as overhead lights, desk lamps, and the curtains, or blinds on nearby windows) to minimize reflections and glare on the monitor screen.
- Use a chair that provides good lower back support.
- Keep your forearms horizontal with your wrists in a neutral, comfortable position while using the keyboard or mouse.
- Always leave space to rest your hands while using the keyboard or mouse.
- Let your upper arms rest naturally on both sides.
- Ensure that your feet are resting flat on the floor.
- When sitting, make sure that the weight of your legs is on your feet and not on the front portion of your seat. Adjust your chair height or use a footrest if necessary to maintain a proper posture.
- Vary your work activities. Try to organize your work so that you do not have to sit and work for extended periods of time. Try to stand or get up and walk around at regular intervals.
- Keep the area under your desk clear of obstructions and cables or power cords that may interfere with comfortable seating or present a potential trip hazard.

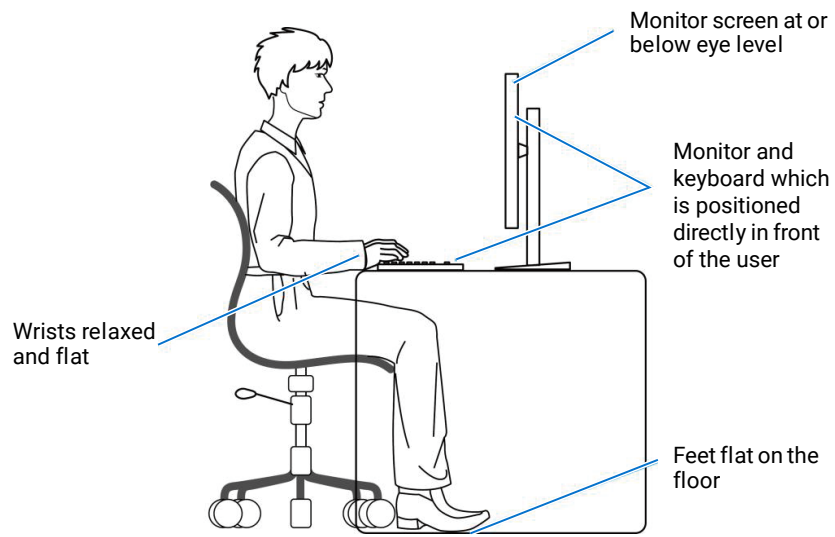

Figure 7. Ergonomics

Handling and moving your display

To ensure that the monitor is handled safely when lifting or moving it, follow these guidelines:

- Before moving or lifting the monitor, turn off your computer and the monitor.
- Disconnect all cables from the monitor.
- Place the monitor in the original box with the original packing materials.
- Hold the bottom edge and the side of the monitor firmly without applying excessive pressure when lifting or moving the monitor.

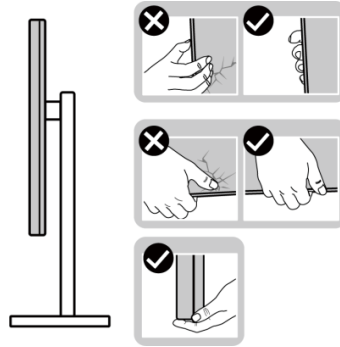

Figure 8. Handling the display

- When lifting or moving the monitor, ensure that the screen is facing away from you and do not press on the display area to avoid any scratches or damage.

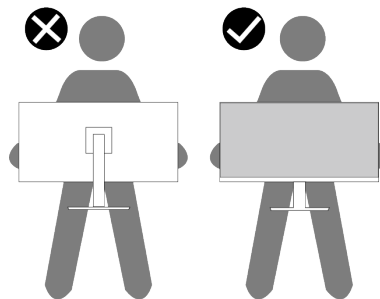

Figure 9. Ensure that the screen is facing away from you

- When transporting the monitor, avoid any sudden shock or vibration to it.
- When lifting or moving the monitor, do not turn the monitor upside down while holding the stand base or stand riser. This may result in accidental damage to the monitor or cause personal injury.

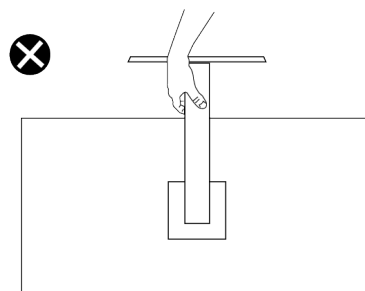

Figure 10. Do not turn the monitor upside down

Maintenance guidelines

Cleaning your monitor

△ **CAUTION:** Read and follow the [Safety instructions](#) before cleaning the monitor.

△ **WARNING:** Before cleaning the monitor, unplug the monitor power cable from the electrical outlet.

For best practices, follow the instructions in the list below when unpacking, cleaning, or handling your monitor:

- Use a clean cloth that is slightly dampened with water to clean the stand assembly, the screen, and the chassis of your Dell monitor. If available, use a screen-cleaning tissue or solution suitable for cleaning Dell monitors.
- After cleaning the surface of the table, ensure that it is thoroughly dry and free from any moisture or cleaning agent before placing your Dell monitor on it.
- △ **CAUTION:** Do not use detergents or other chemicals such as benzene, thinner, ammonia, abrasive cleaners, alcohol, or compressed air.
- △ **CAUTION:** Using chemicals for cleaning may cause changes in the appearance of the monitor, such as color fading, milky film on the monitor, deformation, uneven dark shade, and peeling of screen area.
- △ **WARNING:** Do not spray the cleaning solution or even water directly on the surface of the monitor. Doing so will allow liquids to accumulate at the bottom of the display panel and corrode the electronics resulting in permanent damage. Instead, apply the cleaning solution or water to a soft cloth and then clean the monitor.
- ① **NOTE:** Monitor damage due to improper cleaning methods and the use of benzene, thinner, ammonia, abrasive cleaners, alcohol, compressed air, detergent of any kind leads to a Customer Induced Damage (CID). CID is not covered under the standard Dell warranty.
- If you notice white residual powder when you unpack your monitor, wipe it off with a cloth.
- Handle your monitor with care as a darker-colored monitor may get scratched and show white scuff marks more than a lighter-colored monitor.
- To help maintain the best image quality on your monitor, use a dynamically changing screen saver and turn off your monitor when not in use.

Setting up the monitor

Attaching the stand

① **NOTE:** The stand is not installed at the factory when shipped.

① **NOTE:** The following instructions are applicable only for the stand that was shipped with your monitor. If you are attaching a stand that you purchased from any other source, follow the setup instructions that were included with the stand.

To attach the monitor stand:

1. Lower the side of the box with the handle, remove the VESA cover, the stand riser, and stand base from the packaging cushion.

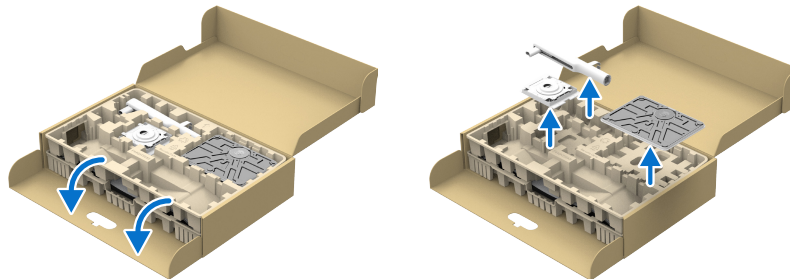

Figure 11. Remove the stand riser and stand base

① **NOTE:** The images are for the illustration purposes only. The placement and appearance of the package cushion may vary by model.

2. Insert the stand base blocks fully into the stand slot.
3. Lift the screw handle and turn the screw clockwise.
4. Fold the screw handle flat within the recess.

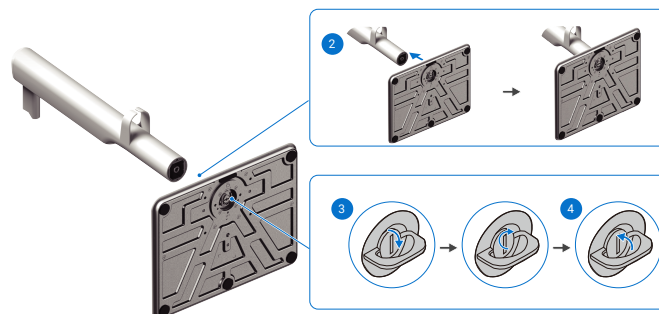

Figure 12. Install the stand riser and stand base

5. Insert the VESA cover to the stand riser.
6. Tilt the VESA cover back so that it sits flush with the thumbscrew for ease of tightening.
7. Lift the screw handle and turn the screw clockwise.
8. Fold the screw handle flat within the recess.



Figure 13. Install the VESA cover and stand riser

9. Open the protective cover, as shown, to access the VESA area for stand assembly.

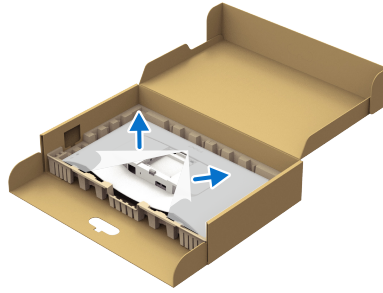

Figure 14. Open the protective cover

NOTE: Ensure that the front plate flap is fully opened before attaching the stand assembly to the display.

10. Attach the stand assembly to the display.

- a. Fit the two tabs on the upper part of the stand to the groove on the back of the display.
- b. Press the stand down till it snaps into place.



Figure 15. Attach the stand assembly to the display

11. Hold the stand riser and lift the monitor carefully, then place it on a flat surface.

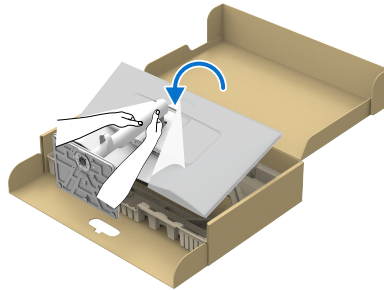

Figure 16. Hold the stand riser and lift the monitor

CAUTION: Lift the monitor carefully to prevent it from slipping or falling.

12. Remove the cover from the monitor.

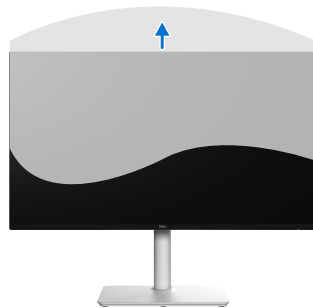

Figure 17. Remove the cover from the monitor

Connecting your monitor

- ⚠ WARNING:** Before you begin any of the procedures in this section, follow the [Safety instructions](#).
- ⚠ WARNING:** For your safety, be sure that the grounded power outlet you plug the power cable into is easily accessible to the operator and located as close to the equipment as possible.
To disconnect power from the equipment, unplug the power cable from the power outlet by grasping the plug firmly. Never pull on the cord.
- ⚠ WARNING:** A certified power supply cable has to be used with this equipment. The relevant national installation and/or equipment regulations shall be considered. A certified power supply cable not lighter than ordinary polyvinyl chloride flexible cord according to IEC 60227 (designation H05VV-F 3G 0.75 mm² or H05VVH2-F2 3G 0.75 mm²) shall be used. An alternative flexible cord is synthetic rubber.
- ⓘ NOTE:** Dell monitors are designed to work optimally with the Dell-supplied cables inside the box. Dell does not guarantee the video quality and performance if non-Dell cables are used.
- ⓘ NOTE:** Do not connect all the cables to the computer at the same time.
- ⓘ NOTE:** The images are for the purpose of illustration only. The appearance of the computer may vary.

To connect your monitor to the computer:

1. Turn off your computer and disconnect the power cable.
2. Connect the DisplayPort or HDMI cable from your monitor to the computer.

Connecting the DisplayPort (DisplayPort to DisplayPort) cable (purchased separately)

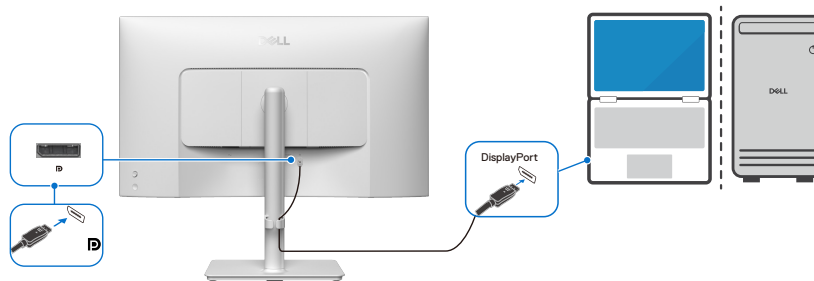

Figure 18. Connecting the DisplayPort cable

Connecting the HDMI cable

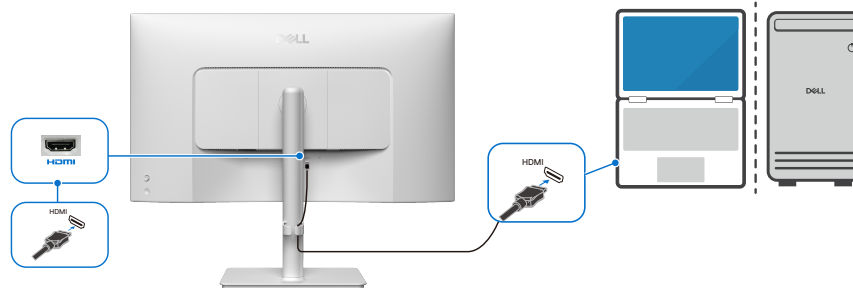

Figure 19. Connecting the HDMI cable

3. Plug the power cables from your computer and monitor into a nearby outlet.

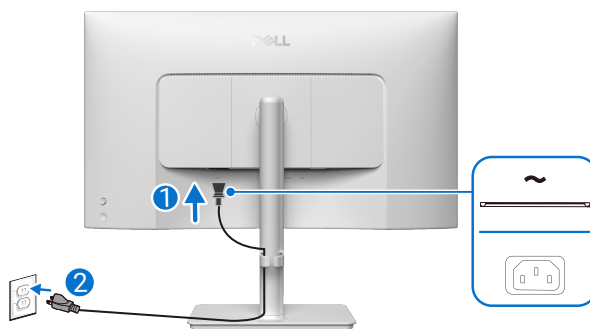

Figure 20. Connecting the power cable

4. Turn on the monitor and the computer.

If your monitor displays an image, installation is complete. If it does not display an image, see [Common problems](#).

Organizing your cables

Route the cables through the cable management guide on the stand riser.

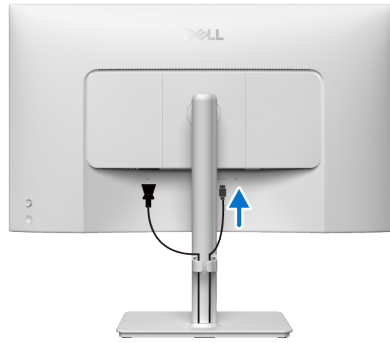

Figure 21. Organizing your cables

After connecting all necessary cables to your monitor and computer, organize all cables as shown in the image. (see [Connecting your monitor](#) for cable attachment)

If your cable is not able to reach your computer, you may connect directly to the computer without routing through the cable management guide on the monitor stand.

Securing your monitor using Kensington lock (optional)

The security-lock slot is located at the bottom of the monitor (see [Security-lock slot](#)). Secure your monitor to a table using the Kensington security lock.

For more information on using the Kensington lock (sold separately), see the documentation that is shipped with the lock.

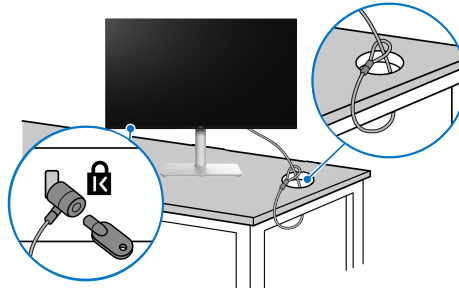

Figure 22. Using Kensington lock

NOTE: The image is for the purpose of illustration only. The appearance of the lock may vary.

Removing the monitor stand

NOTE: To prevent scratches on the LCD screen when removing the stand, ensure that the monitor is placed on a soft surface and handle it carefully.

NOTE: The following steps are applicable only for removing the stand that is shipped with your monitor. If you are removing a stand that you purchased from any other source, follow the setup instructions that are included with the stand.

NOTE: Before removing the stand, ensure that you have disconnected all the cables from the monitor.

To remove the stand:

1. Place the monitor on a soft cloth or cushion.
2. Press and hold the stand release button at the back of the display.
3. Lift the stand assembly up and away from the monitor.

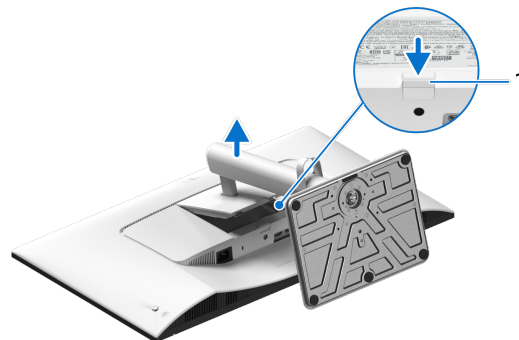

Figure 23. Removing the monitor stand

Table 17. Components and descriptions.

Label	Description	Use
1	Stand release button	Releases the stand from the monitor.

VESA wall-mounting (optional)

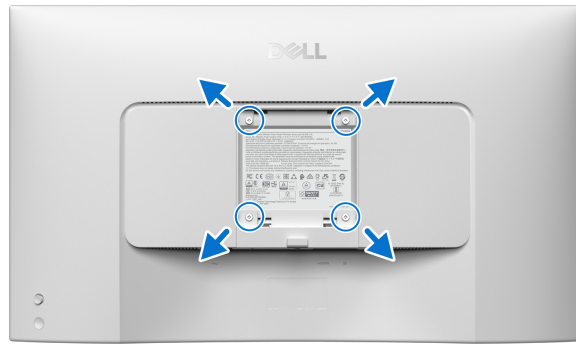

Figure 24. VESA wall-mounting

NOTE: Use M4 x 10 mm screws to connect the monitor to the wall-mounting kit. See the documentation that is shipped with the VESA-compatible wall-mounting kit.

1. Place the monitor panel on a soft cloth or cushion on a stable flat table.
2. Remove the stand (see [Removing the monitor stand](#)).
3. Using a Phillips crosshead screwdriver, remove the four screws securing the plastic cover.
4. Attach the mounting bracket from the wall-mounting kit to the monitor.
5. Mount the monitor on the wall. For more information, see the documentation that is shipped with the wall-mounting kit.

NOTE: Mount the monitor using only UL/CSA/GS-listed wall mount bracket with minimum weight or load-bearing capacity (17.36 kg/38.27 lb).

Using the tilt, swivel, pivot and height adjustment

① **NOTE:** The following instructions are applicable only for attaching the stand that was shipped with your monitor. If you are attaching a stand that you purchased from any other source, follow the setup instructions that were included with the stand.

Tilt and swivel adjustment

With the stand attached to the monitor, you can tilt and swivel the monitor for the most comfortable viewing angle.

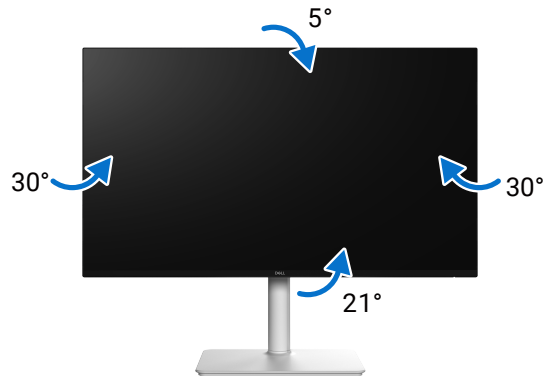

Figure 25. Tilt and swivel adjustment

① **NOTE:** The stand assembly is not pre-installed when the monitor is shipped from the factory.

Height adjustment

① **NOTE:** The stand can extend vertically up to 110 mm. The following image illustrates how to extend the stand vertically.

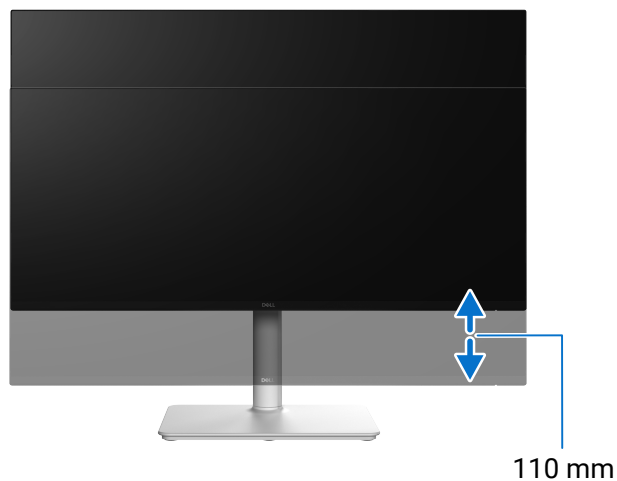

Figure 26. Height adjustment

Pivot adjustment

Before you rotate the display, ensure it is completely extended vertically and completely tilted up to avoid hitting the bottom edge of the monitor.



Figure 27. Pivot adjustment

Rotate clockwise



Figure 28. Rotate clockwise

Rotate counterclockwise



Figure 29. Rotate counterclockwise

NOTE: To use the Display Rotation function (Landscape versus Portrait view) with your Dell computer, you require an updated graphics driver that is not included with this monitor. For latest driver updates, see the Download section for video drivers on [Dell Support Site](#).

① **NOTE:** In the Portrait mode, you may experience performance degradation when using graphic-intensive applications such as 3D gaming.

Adjusting the rotation display settings of your system

After you have rotated your monitor, you need to complete the procedure below to adjust the Rotation Display Settings of your system.

① **NOTE:** If you are using the monitor with a non-Dell computer, go to the graphics driver website or your computer manufacturer website for information on rotating the 'contents' on your display.

To adjust the rotation display settings:

1. Right-click on the desktop and click **Properties**.
 2. Select the **Settings** tab and click **Advanced**.
 3. If you have an AMD graphics card, select the **Rotation** tab and set the preferred rotation.
 4. If you have an NVIDIA graphics card, click the **NVIDIA** tab, in the left-hand column select **NVRotate**, and then select the preferred rotation.
 5. If you have an Intel graphics card, select the **Intel** graphics tab, click **Graphic Properties**, select the **Rotation** tab, and then set the preferred rotation.
- ① **NOTE:** If you do not see the rotation option or it is not working correctly, go to [Dell Support Site](#) and download the latest driver for your graphics card.

Operating the monitor

Turn on the monitor

Press the power button to turn on the monitor.



Figure 30. Turn on the monitor

Using the joystick control

Use the joystick control on the rear of the monitor to make On-Screen Display (OSD) adjustments.

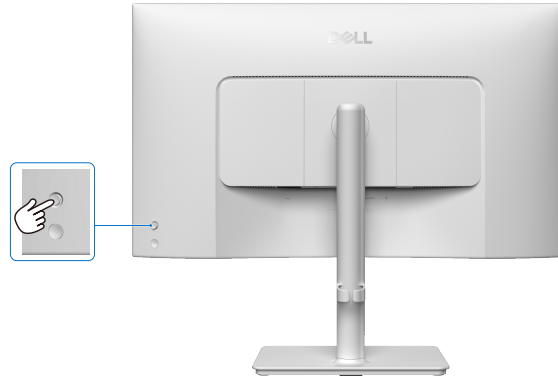

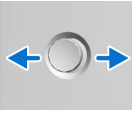



Figure 31. Using the joystick control

1. Press the joystick to launch the Menu Launcher.
2. Adjust the joystick in any direction-up, down, left, or right to navigate through the options.
3. Press the joystick again to confirm the selection.

Table 18. Using the joystick control.

Joystick	Description
	<p>When there is no OSD on the screen, press the joystick to launch the Menu Launcher. See Accessing the Menu Launcher.</p> <p>When the OSD is displayed, press the joystick to confirm the selection or save the settings.</p>
	<p>For two way (right and left) directional navigation.</p> <p>Move right to enter the submenu.</p> <p>Move left to the upper-level menu or exit from the current menu.</p>
	<p>For two way (up and down) directional navigation.</p> <p>Navigates between the menu items.</p> <p>Increases (up) or decreases (down) the parameters of the selected menu item.</p>

Using the On-Screen Display (OSD) menu

Accessing the Menu Launcher

When you toggle or press the joystick, the Menu Launcher appears to let you access the OSD main menu and shortcut functions.

To select a function, move the joystick.

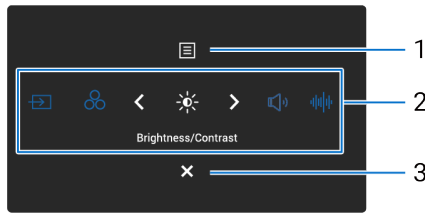









Figure 32. Accessing the Menu Launcher

Table 19. Describes the Menu Launcher functions:

Label	Icon	Description
1	 Menu	To launch the On-Screen Display (OSD) main menu. See Accessing the menu system .
When you move the joystick to the left or right to switch through the shortcut functions, the selected item is highlighted and shifted to the center position. Press the joystick to enter its submenu.		
(i) NOTE: You can set your preferred shortcut keys. For more information, see Personalize .		
2	 Shortcut key 1	Input Source: To choose an input source from the listed video signals.
	 Shortcut key 2	Preset Modes: To choose a preferred color mode from the list of preset modes.
	 Shortcut key 3	Brightness/Contrast: To access the adjustment sliders of brightness and contrast.
	 Shortcut key 4	Volume: To access the adjustment slider of Volume.
	 Shortcut key 5	Audio Profiles: To choose a preferred audio mode from the list of audio profiles.
(i) NOTE: After you change the settings, follow the navigation keys to confirm the changes before proceeding to another function or exiting.		
3	 Exit	To exit the Menu Launcher.

Using the navigation keys

When the OSD main menu is active, move the joystick to configure the settings. Following are the navigation keys displayed below the OSD.



Figure 33. Navigation keys

Table 20. Control buttons and descriptions.

Control Buttons	Description
^ Up	Use the Up navigation key to adjust (increase ranges) items in the OSD menu.
v Down	Use the Down navigation key to adjust (decrease ranges) items in the OSD menu.
< Left	For the first level in the Menu list, use the Left navigation key to exit/close the OSD menu.
> Right	For all other levels except the first level in the Menu list, the Right navigation key goes to the next level.
✓ OK	Press the joystick to confirm your selection.

NOTE: To exit the current menu item and return to the previous menu, move the joystick to the left until you exit.

Direct Key functions

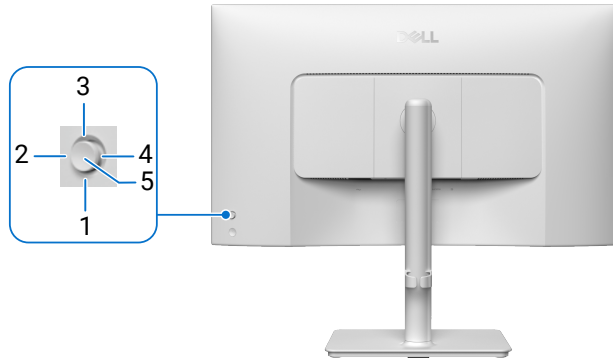

Figure 34. Direct Key

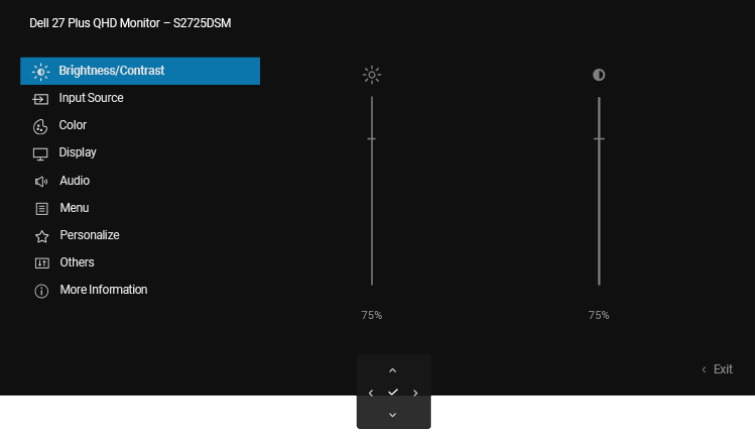

Table 21. Control buttons and descriptions.

Control Buttons		Description
1	▼ Direct Key 1	Allows you to choose a feature from Off, Menu Launcher, Preset Modes, Brightness, Contrast, Input Source, Aspect Ratio, Rotation, Volume, Display Info, or Audio Profiles and set it as a Direct Key 1.
2	> Direct Key 2	Allows you to choose a feature from Off, Menu Launcher, Preset Modes, Brightness, Contrast, Input Source, Aspect Ratio, Rotation, Volume, Display Info, or Audio Profiles and set it as a Direct Key 2.
3	^ Direct Key 3	Allows you to choose a feature from Off, Menu Launcher, Preset Modes, Brightness, Contrast, Input Source, Aspect Ratio, Rotation, Volume, Display Info, or Audio Profiles and set it as a Direct Key 3.
4	< Direct Key 4	Allows you to choose a feature from Off, Menu Launcher, Preset Modes, Brightness, Contrast, Input Source, Aspect Ratio, Rotation, Volume, Display Info, or Audio Profiles and set it as a Direct Key 4.
5	✓ Menu Launcher	To access the Menu Launcher.

Accessing the menu system

NOTE: After you change the settings, press the joystick to save the changes before exiting or proceeding to another menu.

Table 22. OSD tree list.

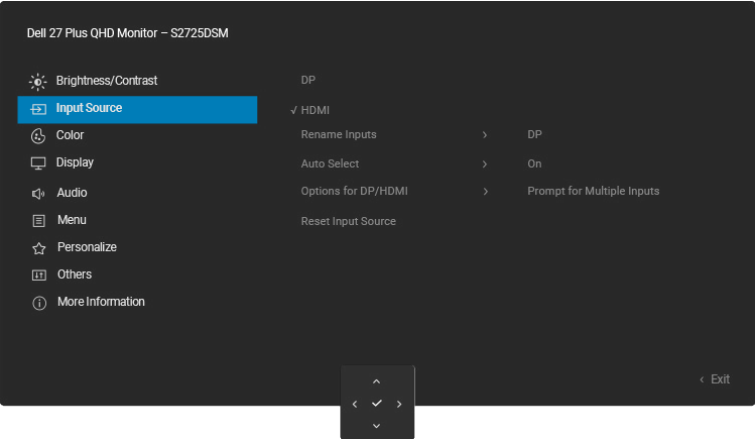
Icon	Menu and submenus	Description
	Brightness/Contrast	Adjusts the brightness and the contrast of the display. 
	Brightness	Brightness adjusts the luminance of the backlight. Move the joystick up or down to increase or decrease the brightness level (min. 0/max. 100). NOTE: When MPRT is selected, the brightness level can be adjusted separately and the maximum brightness at 100% is lower.
	Contrast	Adjust the Brightness first, and then adjust the Contrast only if further adjustment is necessary. The Contrast function adjusts the degree of difference between darkness and lightness on the monitor screen. Move the joystick up or down to increase or decrease the contrast level (min. 0/max. 100).
	Input Source	Selects between the different video signals that may be connected to your monitor. 
	DP	Select DP when you are using the DisplayPort (DP) connector. Press the joystick to confirm the selection.
	HDMI	Select HDMI when you are using the HDMI port. Press the joystick to confirm the selection.
	Rename Inputs	Allows you to specify a preset input name for the selected input source. The preset options are PC, PC 1, PC 2, Laptop, Laptop 1, and Laptop 2 . The default setting is Off . NOTE: It is not applicable for the input names that are shown in the warning messages and Display Info .
	Auto Select	Allows you to scan for available input sources. The default is On .

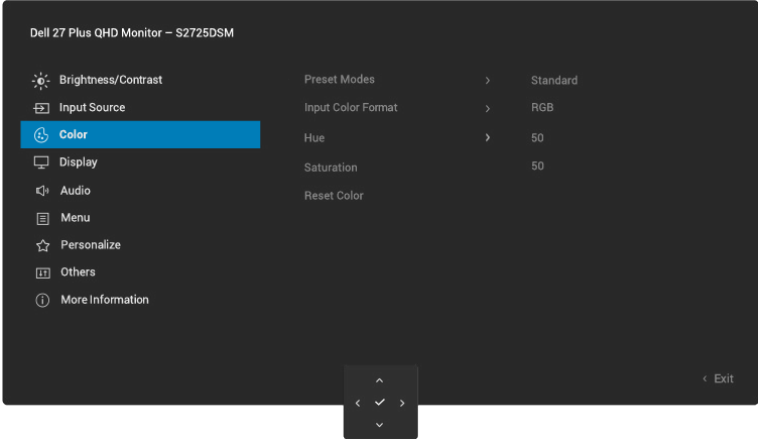
Icon	Menu and submenus	Description
	Options for DP/HDMI	<p>Allows you to set Auto Select for DP/HDMI to:</p> <ul style="list-style-type: none"> • Prompt for Multiple Inputs: Always displays the "Switch to DP/HDMI Video Input" message for you to choose whether to switch or not. • Always Switch: Automatically switches to DP/HDMI video input (without prompting) when the DisplayPort or HDMI cable is connected. • Off: Never automatically switches to DP/HDMI video input when the DP/HDMI cable is connected. <p>Press the joystick to confirm the selection.</p> <p>(i) NOTE: This function is available when Auto Select is set to On.</p>
	Reset Input Source	<p>Resets all settings under the Input Source menu to the factory defaults.</p>
	Color	<p>Adjusts the color setting mode.</p> 

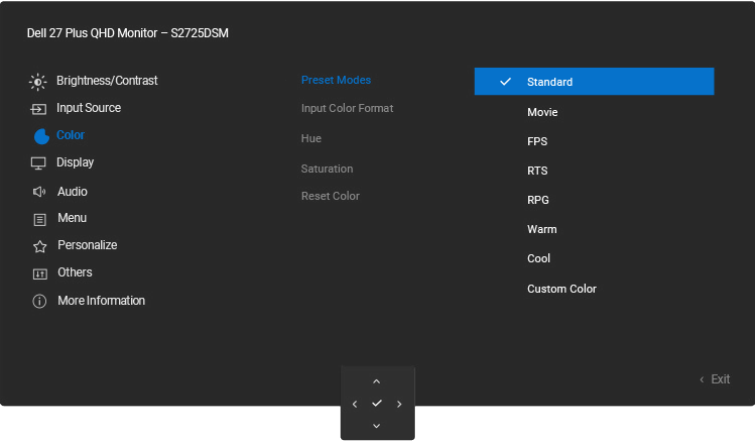
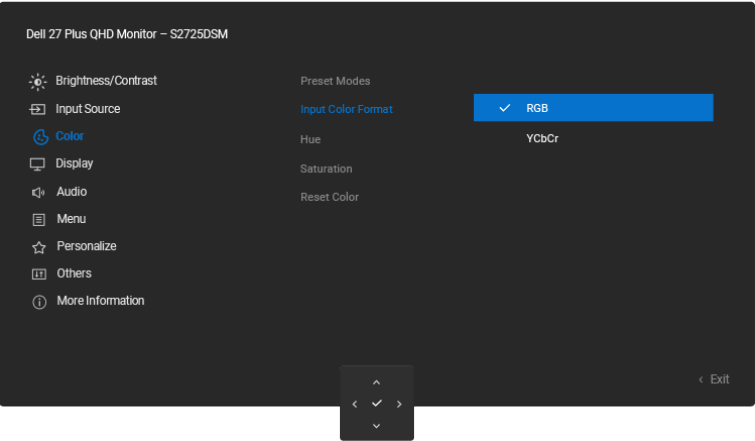
Icon	Menu and submenus	Description
	Preset Modes	<p>Allows you to choose from the list of preset color modes. Press the joystick to confirm the selection.</p> <ul style="list-style-type: none"> • Standard: Loads the monitor's default color settings. This is the default preset mode. • Movie: Loads color settings ideal for movies. • FPS: Loads color settings ideal for First-Person Shooter games. • RTS: Loads color settings ideal for Real-time Strategy games. • RPG: Loads color settings ideal for Role-Playing games. • Warm: Presents colors at lower color temperatures. The screen appears warmer with a red/yellow tint. • Cool: Presents colors at higher color temperatures. The screen appears cooler with a blue tint. • Custom Color: Allows you to manually adjust the color settings (R/G/B) and create your own preset color mode. 
	Input Color Format	<p>Allows you to set the video input mode to:</p> <ul style="list-style-type: none"> • RGB: Select this option if your monitor is connected to a computer or a media player that supports RGB output. • YCbCr: Select this option if your media player supports only YCbCr output. 
	Hue	<p>This function can shift the color of the video image to green or purple. This is used to adjust the desired flesh tone color. Move the joystick to adjust the hue level from 0 to 100.</p> <p>NOTE: The function is available only when you select Movie, FPS, RTS, or RPG mode.</p>

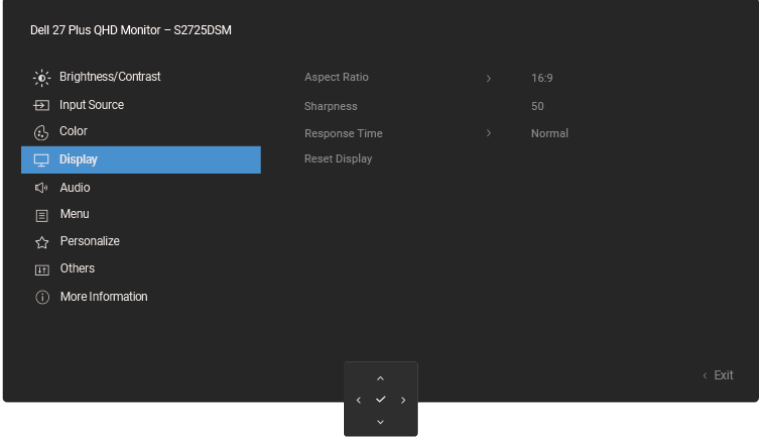
Icon	Menu and submenus	Description
	Saturation	This function can adjust the color saturation of the video image. Move the joystick to adjust the saturation level from 0 to 100. (i) NOTE: The function is available only when you select Movie, FPS, RTS, or RPG mode.
	Reset Color	Resets all settings under the Color menu to the factory defaults.
	Display	Use Display to adjust the image. 
	Aspect Ratio	Adjusts the image ratio to 16:9, 4:3 or 5:4 .
	Sharpness	Adjusts the picture sharpness of the display. Move the joystick to adjust the sharpness level from 0 to 100.
	Response Time	Allows you to set the response time to Normal, Fast, Extreme , or MPRT . (i) NOTE: MPRT helps to reduce visible motion blur. Some users may notice slight brightness flicker. AMD FreeSync will not be supported. (i) NOTE: To turn on MPRT , source refresh rate needs to be 120Hz or higher.
	Reset Display	Resets all settings under the Display menu to the factory defaults.

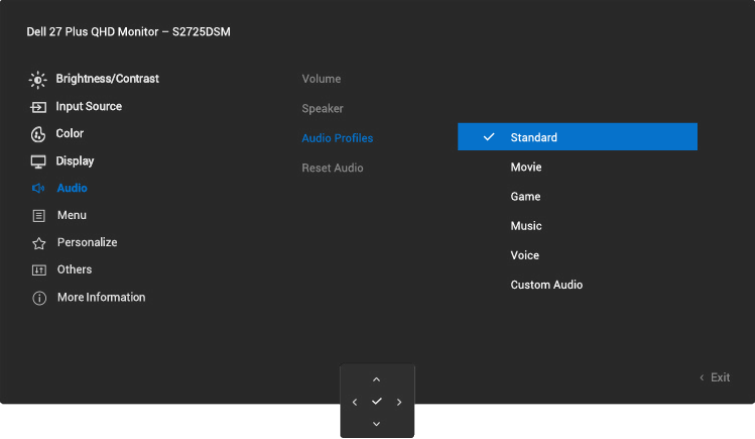
Icon	Menu and submenus	Description
	Audio	Adjusts the audio settings. 
	Volume	Use the buttons to adjust the volume. Minimum is 0 (-). Maximum is 100 (+).
	Speaker	Allows you to turn on or off the speaker function.
	Audio Profiles	Expand to show the various audio profiles.  <ul style="list-style-type: none"> • Standard: Default audio setting. • Movie: For motion picture viewing. • Game: For game. • Music: For listening to music. • Voice: For speech. • Custom Audio: Allows you to manually adjust the sound. Move the joystick right and left to adjust the setting.
	Reset Audio	Resets all settings under the Audio menu to the factory defaults.

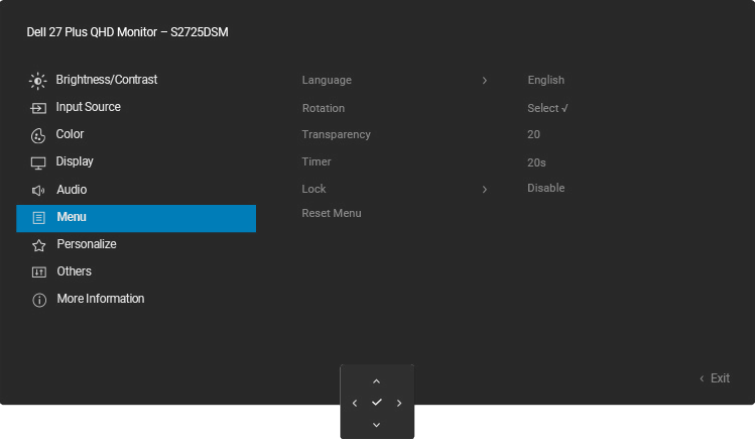
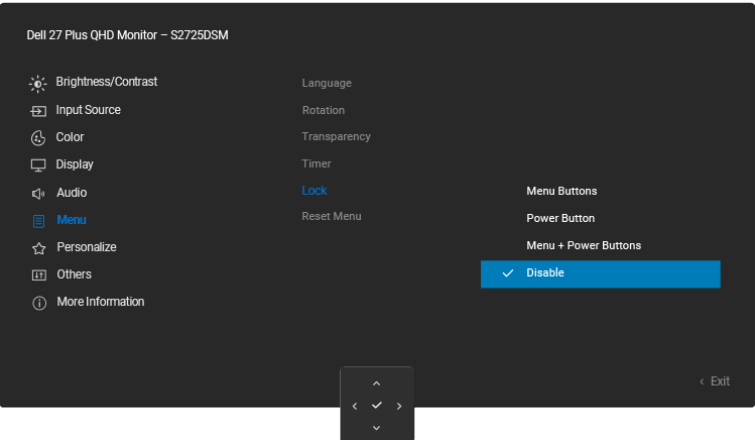
Icon	Menu and submenus	Description
	Menu	<p>Adjusts the settings of the OSD, such as the languages of the OSD, the amount of time the menu remains on screen, and so on.</p> 
	Language	<p>Sets the OSD display to one of the eight languages (English, Spanish, French, German, Brazilian Portuguese, Russian, Simplified Chinese, or Japanese).</p>
	Rotation	<p>Press the joystick to rotate the OSD by 0/90/270 degrees. You can adjust the menu according to your display rotation.</p>
	Transparency	<p>Select to change the menu transparency by moving the joystick (min. 0/max. 100).</p>
	Timer	<p>Sets the length of time for the OSD to remain active after your last operation with the joystick. Move the joystick to adjust the slider in 1 second increments, from 5 to 60 seconds.</p>
	Lock	<p>With the control buttons on the monitor locked, you can prevent others from accessing the controls.</p>  <p>Menu Buttons: All joystick functions are locked and not accessible by the user.</p> <p>Power Button: Only the Power button is locked and not accessible by the user.</p> <p>Menu + Power Buttons: Both the joystick and Power button are locked and not accessible by the user.</p> <p>The default setting is Disable.</p> <p>Alternative Lock Method: You can move and hold the joystick up, down, left, or right for 4 seconds to set the lock options using the menu, and then press the joystick to confirm the configuration.</p> <p>NOTE: To unlock, move and hold the joystick up, down, left, or right for 4 seconds, and then press the joystick to confirm the changes and close the menu.</p>
	Reset Menu	<p>Resets all settings under the Menu to the factory defaults.</p>

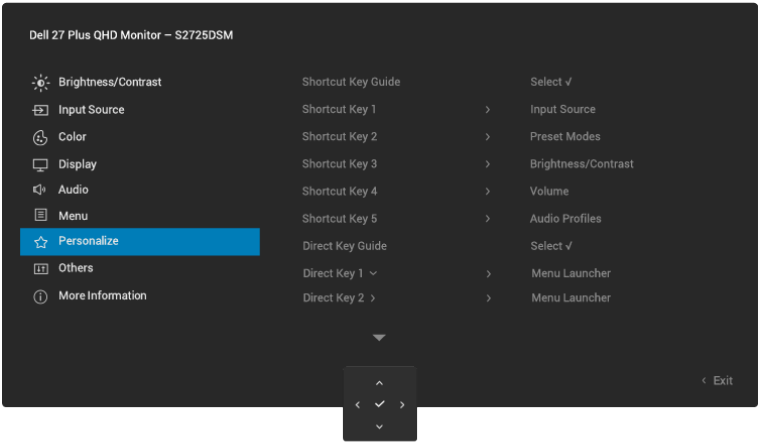
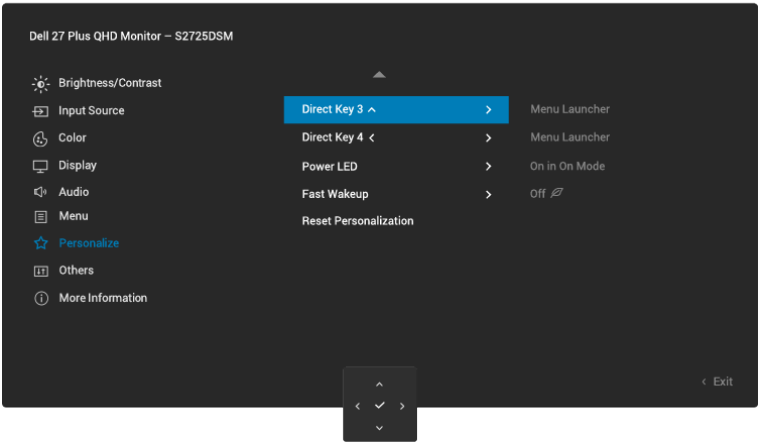
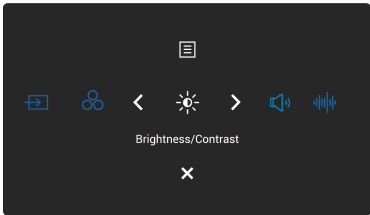
Icon	Menu and submenus	Description
☆	Personalize	<p>Select this option to adjust the settings of the personalization.</p>  
	Shortcut Key Guide	Select this option for entering Shortcut Key Guide .
	Shortcut Key 1	Select a function from Preset Modes, Brightness/Contrast, Input Source, Aspect Ratio, Rotation, Volume, Display Info, or Audio Profiles and set it as a shortcut key in the menu launcher.
	Shortcut Key 2	
	Shortcut Key 3	
	Shortcut Key 4	
	Shortcut Key 5	<p>NOTE: To reduce to 4 Shortcut Keys, go to Shortcut Key 5, and select '-'. Once the '-' in Shortcut Key 5 is selected, the '-' in Shortcut Key 4 will appear.</p>
	Direct Key Guide	Select this option for entering Direct Key Guide .
	Direct Key 1	
	Direct Key 2	
	Direct Key 3	
	Direct Key 4	
	Power LED	Allows you to set the state of the power light to save energy.
	Fast Wakeup	<p>Speeds up recovery time from standby mode.</p> <p>NOTE: In the case of incompatibility arising from use of this setting, please refer to the Common problems to assist in troubleshooting.</p>
	Reset Personalization	Resets all settings under the Personalize menu to the factory defaults.

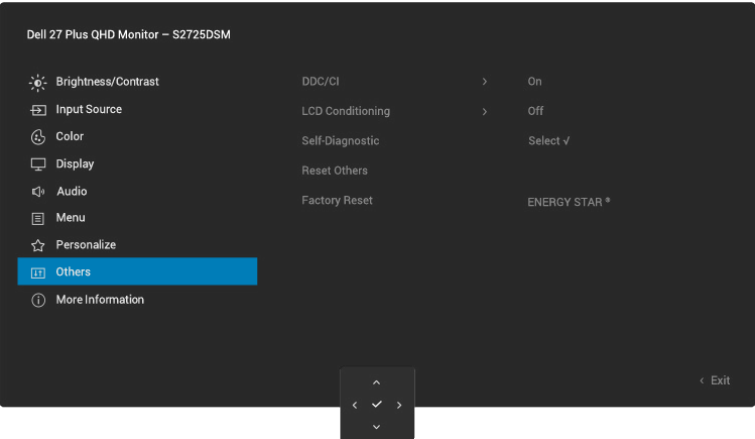
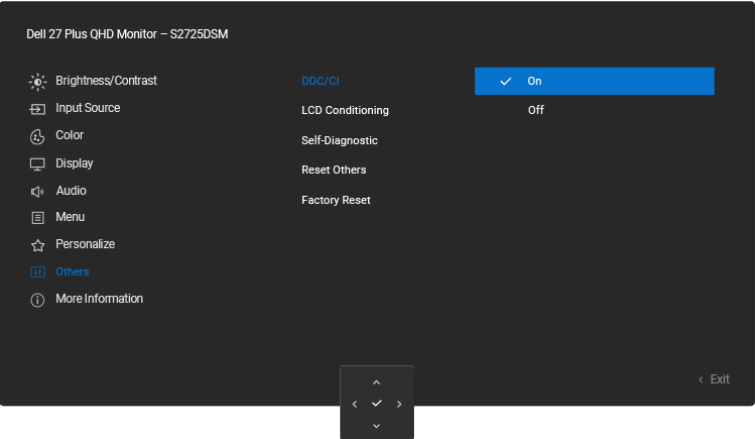
Icon	Menu and submenus	Description
	Others	<p>Adjusts the OSD settings, such as DDC/CI, LCD Conditioning, Self-Diagnostic, and so on.</p> 
	DDC/CI	<p>DDC/CI (Display Data Channel/Command Interface) allows you to adjust the monitor settings using software on your computer. Enable this function for the best user experience and optimum performance of your monitor. You can disable this function by selecting Off.</p> 

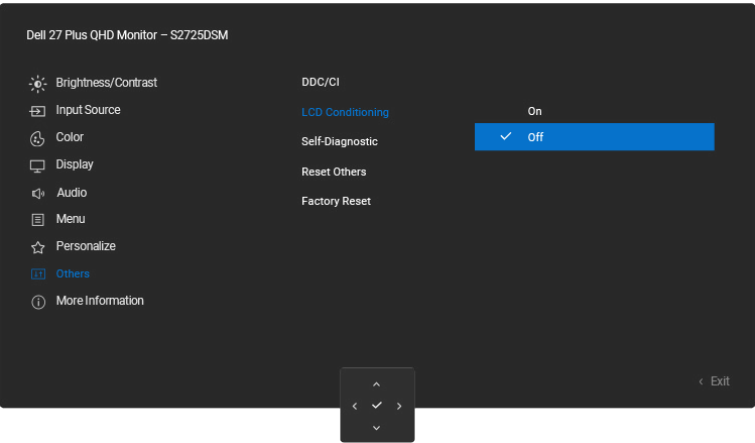
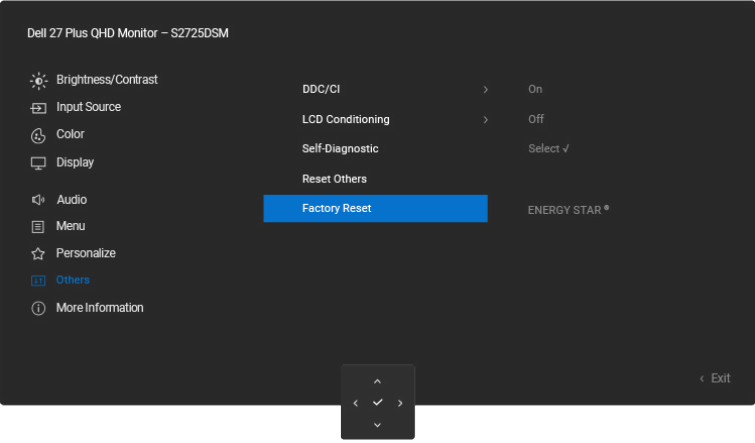
Icon	Menu and submenus	Description
	LCD Conditioning	<p>Helps reduce minor cases of image retention. Depending on the degree of image retention, the program may take some time to run. By default, the setting is Off. You can enable this function by selecting On.</p>  <p>The screenshot shows the OSD menu for a Dell 27 Plus QHD Monitor (S2725DSM). The 'LCD Conditioning' option is highlighted in blue and set to 'Off'. Other menu items include Brightness/Contrast, Input Source, Color, Display, Audio, Menu, Personalize, Others, and More Information. The 'Factory Reset' option is also visible in the bottom right area of the menu.</p>
	Self-Diagnostic	Select this function to run the built-in diagnostics, see Built-in diagnostics .
	Reset Others	Resets all settings under the Others menu to the factory preset values.
	Factory Reset	<p>Restores all preset values to the factory default settings. These are also the settings for ENERGY STAR® tests.</p>  <p>The screenshot shows the OSD menu with 'Factory Reset' highlighted in blue. The 'LCD Conditioning' option is now set to 'Off', and 'Self-Diagnostic' is set to 'Select ✓'. The 'Factory Reset' option is highlighted in blue, and 'ENERGY STAR' is visible in the bottom right area of the menu.</p>

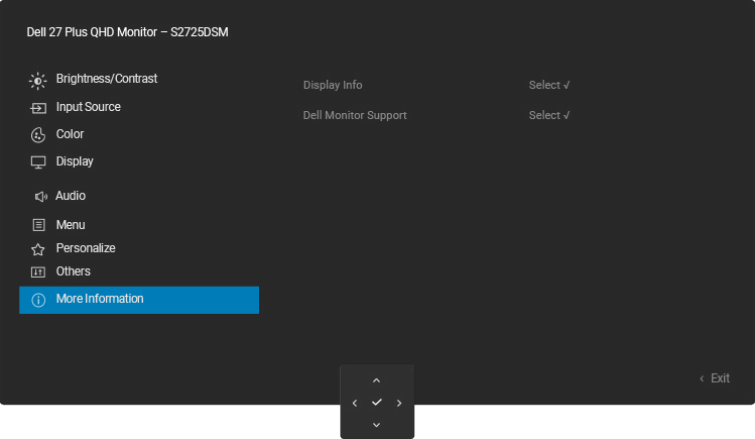
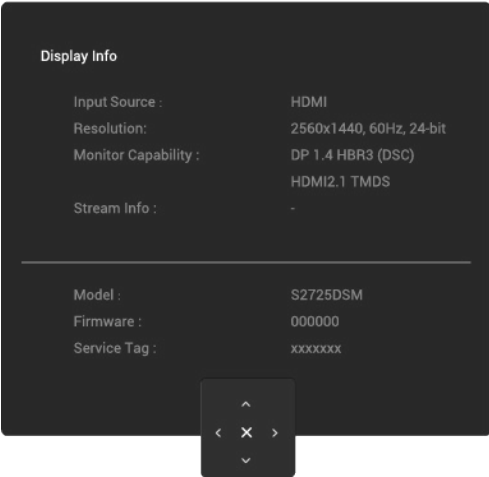
Icon	Menu and submenus	Description
	More Information	<p>Use the menu to view the monitor's information or seek more monitor support.</p> 
	Display Info	<p>Select to display the current settings, firmware version, and service tag of your monitor.</p>  <p>i NOTE: The image shown is for the purpose of illustration only. The information may vary depending on the model and current settings.</p>
	Dell Monitor Support	<p>To access the general monitor support materials for your monitor, use your smartphone to scan the QR code.</p>

OSD messages

Initial Setup

When **Factory Reset** is selected, the following message appears:

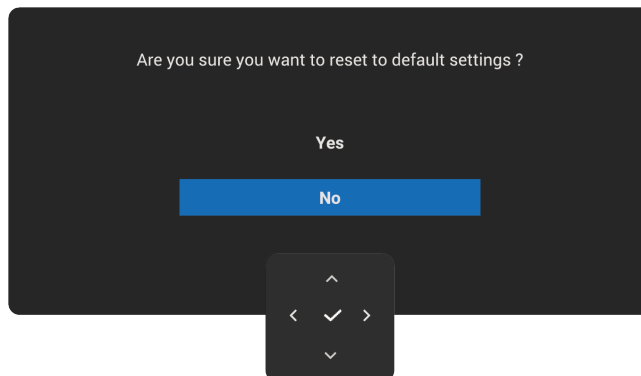

Figure 35. Factory Reset warning message

If you select **Yes** to reset to default settings, or you first turn on the monitor, the following message appears:

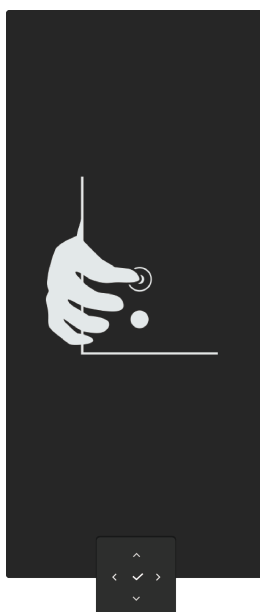

Figure 36. The message of pressing the joystick

If you press the joystick, the following message appears:

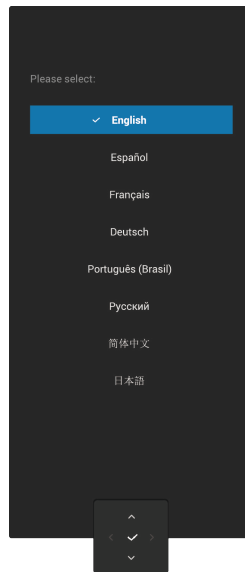

Figure 37. The message of selecting language

OSD warning messages

When the monitor does not support a particular resolution mode, the following message appears:

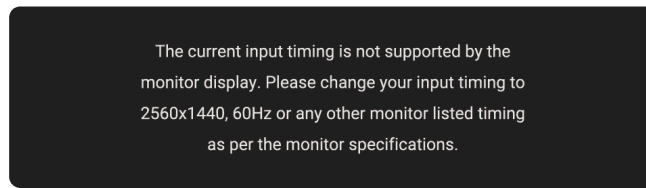

Figure 38. Resolution mode warning message

This means that the monitor cannot synchronize with the signal that it is receiving from the computer. See [Monitor specifications](#) for the Horizontal and Vertical frequency ranges addressable by this monitor. The recommended mode is **2560 x 1440**.

When you adjust the **Brightness** level above the default level for the first time, the following message appears:

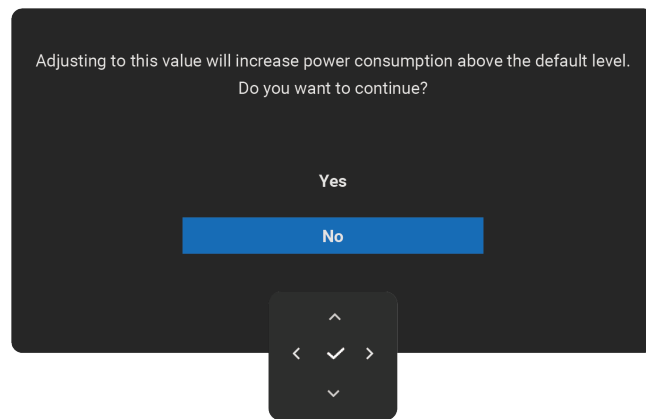

Figure 39. Power warning message

NOTE: If you select **Yes**, the message does not appear the next time you change the **Brightness** setting.

You will see the following message before the **Lock** function is activated:

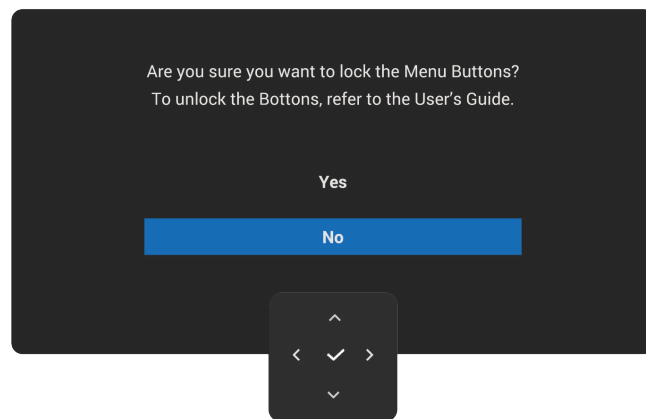

Figure 40. Lock function warning message

NOTE: The message may be slightly different according to the selected settings.

You will see the following message before the **DDC/CI** function is disabled:

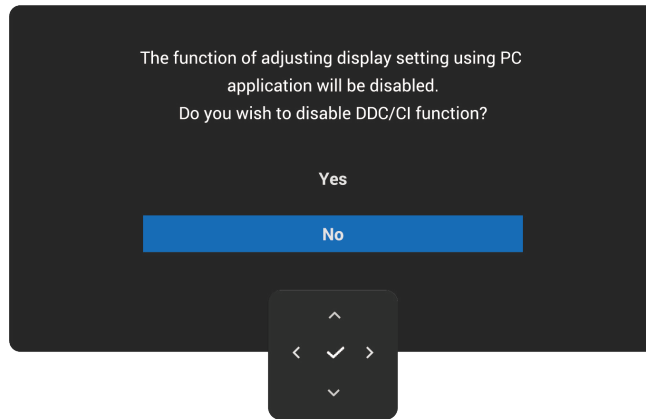

Figure 41. DDC/CI warning message

When the monitor goes into Standby mode, the following message appears:

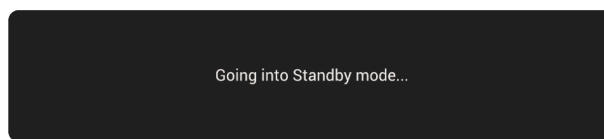

Figure 42. Standby mode warning message

Activate the computer and wake up the monitor to gain access to the OSD.

The OSD functions only in the normal operation mode. If you press the joystick during the Standby mode, the following message appears depending on the selected input:

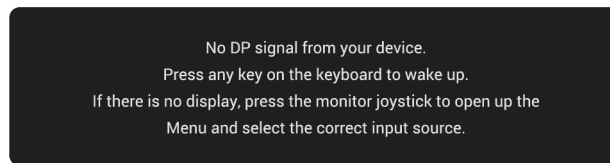

Figure 43. Signal detection warning message

Activate the computer and the monitor to gain access to the OSD.

NOTE: The message may be slightly different according to the selected input signal.

If DisplayPort, HDMI input is selected and the corresponding cable is not connected, the following message appears:

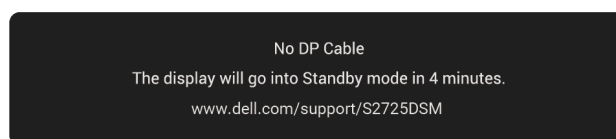

Figure 44. Signal cable disconnected warning message

or

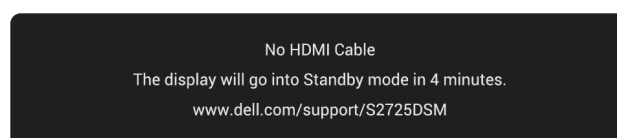

Figure 45. Signal cable disconnected warning message

NOTE: The message may be slightly different according to the selected input signal.

See [Troubleshooting](#) for more information.

Locking the control buttons

You can lock the monitor control buttons to prevent access to the OSD menu and/or power button.

1. Move and hold the joystick up, down, left, or right for about four seconds until a pop-up menu appears.

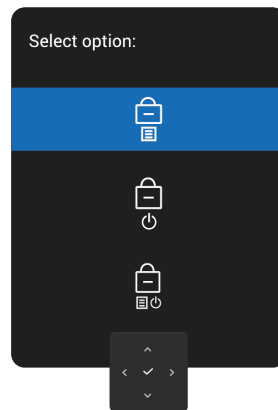

Figure 46. Lock menu

2. Move the joystick to select one of the following options:



: The OSD menu settings are locked and not accessible.



: The power button is locked.



: The OSD menu settings are not accessible, and the power button is locked.

3. Press the joystick to confirm the configuration.

To unlock, move and hold the joystick up, down, left, or right for about four seconds until a menu appears, and then select  to unlock and close the pop-up menu.

Setting the maximum resolution

NOTE: The steps may vary slightly depending on the version of Windows you have.

To set the maximum resolution for the monitor:

In Windows 10 and Windows 11:

1. Right-click on the desktop and click **Display settings**.
2. If you have more than one monitor connected, ensure to select **S2725DSM**.
3. Click the **Display Resolution** drop-down list and select **2560 x 1440**.
4. Click **Keep changes**.

If you do not see **2560 x 1440** as an option, you must update your graphics driver to the latest version. Depending on your computer, complete one of the following procedures:

If you have a Dell desktop or laptop:

- Go to [Dell Support Site](#), enter your Service Tag, and download the latest driver for your graphics card.

If you are using a non-Dell computer (laptop or desktop):

- Go to the support site for your non-Dell computer and download the latest graphics card drivers.
- Go to the graphics card's website and download the latest graphics card drivers.

Troubleshooting

⚠ WARNING: Before you begin any of the procedures in this section, follow the [Safety instructions](#).

Self-test

Your monitor provides a self-test feature that allows you to check whether your monitor is functioning properly. If your monitor and computer are properly connected but the monitor screen remains dark, run the monitor self-test by performing the following steps:

1. Turn off both your computer and the monitor.
2. Unplug the video cable from the computer.
3. Turn on the monitor.

If the monitor cannot sense a video signal and is working correctly, the following message appears:

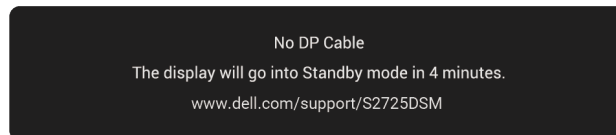

Figure 47. Signal cable disconnected warning message

or

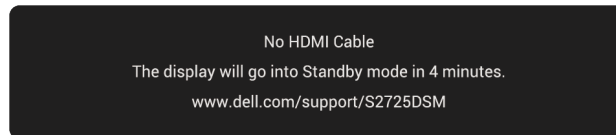

Figure 48. Signal cable disconnected warning message

ⓘ NOTE: The message may differ slightly according to the connected input signal.

ⓘ NOTE: While in self-test mode, the power LED remains white.

4. This message can also appear during normal system operation if the video cable gets disconnected or damaged.
5. Turn off your monitor, reconnect the video cable, and then turn on both the computer and the monitor.

If your monitor screen remains blank after performing the above steps, it indicates the monitor is functioning properly. Check the video controller and computer.

Built-in diagnostics

Your monitor includes a built-in diagnostic tool to help you identify whether the screen abnormality is due to an issue with the monitor itself or with your computer and video card.

To run the built-in diagnostics:

1. Ensure that the screen is clean (no dust particles on the surface of the screen).
2. Press the joystick button to launch the OSD Main Menu.
3. Move the joystick button to select **Others > Self-Diagnostic** to initiate the self-diagnostic process.

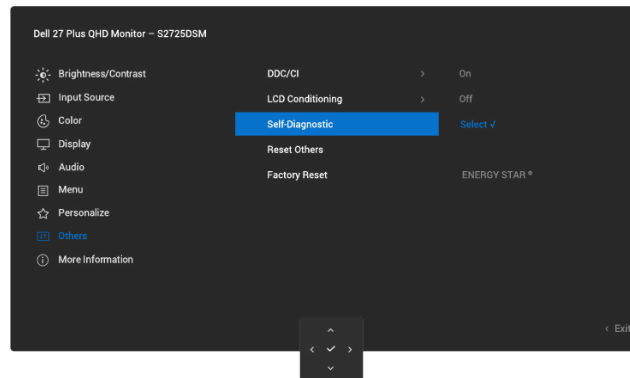

Figure 49. Self-Diagnostic menu

4. When initiated, a gray screen appears. Inspect the screen for abnormalities.
5. Switch the joystick button. The color of the screen changes to red. Inspect the screen for abnormalities.
6. Repeat step 5 and inspect the screen when it displays the colors green, blue, black, and white followed by the on-screen text.

The test is completed when the text screen appears. To exit, toggle the joystick button again.

If you do not detect any screen abnormalities upon using the Built-in diagnostics tool, the monitor is functioning properly. Check the video card and computer.

Common problems

The following table contains general information about common monitor problems that you might encounter and the possible solutions:

Table 23. Common problems.

Common symptoms	What you experience	Possible solutions
No video/power LED off	No picture	<ul style="list-style-type: none"> • Ensure that the video cable connecting the monitor and the computer is properly connected and secure. • Verify that the power outlet is functioning properly using any other electrical equipment. • Ensure that the power button is pressed fully. • Ensure that the correct input source is selected in the Input Source menu.
No video/power LED on	No picture	<ul style="list-style-type: none"> • Increase brightness and contrast controls using the OSD. • Perform monitor self-test feature check. • Check for bent or broken pins in the video cable connector. • Run the built-in diagnostics. For more information, see Built-in diagnostics. • Ensure that the correct input source is selected in the Input Source menu.
Poor focus	Picture is fuzzy, blurry, or ghosting	<ul style="list-style-type: none"> • Disconnect video extension cables. • Reset the monitor to factory settings (Factory Reset). • Change the video resolution to the correct aspect ratio.
Shaky/jittery video	Wavy picture or fine movement	<ul style="list-style-type: none"> • Reset the monitor to factory settings (Factory Reset). • Check environmental factors. • Relocate the monitor and test in another room.
Missing pixels	LCD screen has spots	<ul style="list-style-type: none"> • Cycle power On-Off. • Pixel that is permanently off is a natural defect that can occur in LCD technology. • For more information about Dell Monitor Quality and Pixel Policy, see Dell Display Pixel Guidelines.
Stuck-on pixels	LCD screen has bright spots	<ul style="list-style-type: none"> • Cycle power On-Off. • A pixel that is permanently off is a natural defect that can occur in LCD technology. • For more information about Dell Monitor Quality and Pixel Policy, see Dell Display Pixel Guidelines.
Geometric distortion	Screen not centered correctly	<ul style="list-style-type: none"> • Reset the monitor to factory settings (Factory Reset).
Horizontal or vertical lines	Screen has one or more lines	<ul style="list-style-type: none"> • Reset the monitor to factory settings (Factory Reset). • Perform a monitor self-test feature check (see Self-test) and determine if these lines are also in self-test mode. • Check for bent or broken pins in the video cable connector. • Run the built-in diagnostics. For more information, see Built-in diagnostics.
Synchronization problems	Screen is scrambled or appears torn	<ul style="list-style-type: none"> • Reset the monitor to factory settings (Factory Reset). • Perform monitor self-test feature check (see Self-test) to determine if the scrambled screen appears in self-test mode. • Check for bent or broken pins in the video cable connector. • Restart the computer in the safe mode.
Safety-related issues	Visible signs of smoke or sparks	<ul style="list-style-type: none"> • Do not perform any troubleshooting steps. • Contacting Dell immediately.

Common symptoms	What you experience	Possible solutions
Intermittent problems	Monitor malfunctions on and off	<ul style="list-style-type: none"> • Ensure that the video cable connecting the monitor to the computer is connected properly and is secure. • Reset the monitor to factory settings (Factory Reset). • Perform the monitor self-test feature check (see Self-test) to determine if the scrambled screen appears in self-test mode.
Missing color	Picture is missing color	<ul style="list-style-type: none"> • Perform monitor self-test feature check (see Self-test). • Ensure that the video cable connecting the monitor to the computer is connected properly and is secure. • Check for bent or broken pins in the video cable connector.
Wrong color	Picture color is not good	<ul style="list-style-type: none"> • Change the settings of the Preset Modes in the Color menu OSD depending on the application. • Adjust the R/G/B values under Custom Color in the Color menu OSD. • Change the Input Color Format to RGB or YCbCr in the Color settings OSD. • Run the built-in diagnostics. For more information, see Built-in diagnostics.
Image retention from a static image left on the monitor for a long period of time	A faint shadow from the static image displayed appears on the screen	<ul style="list-style-type: none"> • Set the screen to turn off after a few minutes of screen idle time. These can be adjusted in the Windows Power Options or Mac Energy Saver setting. • Alternatively, use a dynamically changing screensaver.
Video ghosting or overshooting	Video ghosting, shadows, or color smear while scrolling	<ul style="list-style-type: none"> • Change the Response Time in the Display menu OSD to Normal.
Screen image is too small	The image is centered on the screen, but does not fill the entire viewing area	<ul style="list-style-type: none"> • Check the Aspect Ratio setting in the Display menu OSD. • Reset the monitor to factory settings (Factory Reset).
Cannot adjust the monitor with the joystick	OSD does not appear on the screen	<ul style="list-style-type: none"> • Turn off the monitor, unplug the power cable, plug it back, and then turn on the monitor. • Check whether the OSD menu is locked. If yes, move and hold the joystick up/down/left/right for 4 seconds to unlock (see Lock and Locking the control buttons).
No input signal when you press the power button or move the joystick	No picture, the LED light is white	<ul style="list-style-type: none"> • Check the signal source. Ensure the computer is not in the power-saving mode by moving the mouse or pressing any key on the keyboard. • Check whether the signal cable is plugged in properly. Re-plug the signal cable if necessary. • Reset the computer or video player.
The picture does not fill the entire screen	The picture cannot fill the height or width of the screen	<ul style="list-style-type: none"> • Due to different video formats (aspect ratio) of DVDs, the monitor may not display in full screen. • Run the built-in diagnostics. For more information, see Built-in diagnostics.
No video at HDMI port/ DisplayPort	When connected to some dongle/docking device at the port, there is no video when unplugging/plugging the cable from the laptop	<ul style="list-style-type: none"> • Unplug the HDMI/DisplayPort cable from the dongle/docking device, then plug the HDMI/DisplayPort cable directly into the laptop.
The display remains in standby mode or unable to resume from suspend with an attached device(s), for example external streaming dongle	Power LED breathing	<ul style="list-style-type: none"> • Press Monitor Joystick button on the remote to wake up from sleep mode. • And then enable the Fast Wakeup in the Personalize menu OSD.

Regulatory information

FCC notices (U.S. Only) and other regulatory information

For FCC notices and other regulatory information, see the regulatory compliance website at [Dell Regulatory Compliance Home Page](#).

EU product database for energy label and product information sheet

For more information about the energy labeling regulations, see the [European Product Registry for Energy Labeling](#)

Contacting Dell

To contact Dell for sales, technical support, or customer service issues, see [Contact Support at Dell Support Site](#).

- ① **NOTE:** Availability varies by country, region, or product, and some services may not be available in your country.
- ① **NOTE:** If you do not have an active Internet connection, you can find contact information in your purchase invoice, packing slip, bill, or Dell product catalog.

Revision History

The following table provides the revision history of this document:

Table 24. Revision History.

Revision	Date	Description
A00	September 2025	Original publish date
A01	October 2025	Revised the fonts, and updated all illustration artifacts and hyperlinks to meet Accessibility Compliance guidelines.